



芯善物科技

MPVX20N65B Series Power MOSFET

FEATURES

- BV_{DSS} : 650V, $I_D=20A$
- $R_{DS(on)}$: 0.45Ω(Max) @ $V_{GS}=10V$
- Very Low FOM ($R_{DS(on)} * Q_g$)
- Excellent stability and uniformity

APPLICATIONS

- Switch Mode Power Supply (SMPS)
- Uninterruptible Power Supply (UPS)
- Power Factor Correction (PFC)
- AC to DC Converters

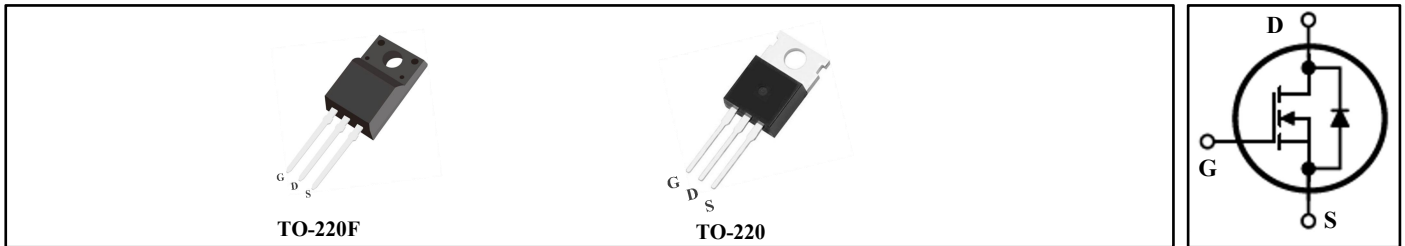

Ordering Information		
Type NO.	Marking	Package Code
MPVA20N65B	MPVA20N65B	TO-220F
MPVP20N65B	MPVP20N65B	TO-220

Absolute Maximum Ratings $T_C = 25^\circ C$, unless otherwise noted				
Parameter	Symbol	Value		Unit
		220F	220	
Drain-Source Voltage ($V_{GS} = 0V$)	V_{DSS}	650		V
Continuous Drain Current	I_D	20		A
Pulsed Drain Current (note1)	I_{DM}	80		A
Gate-Source Voltage	V_{GSS}	± 30		V
Single Pulse Avalanche Energy (note2)	E_{AS}	1500		mJ
Avalanche Current (note1)	I_{AR}	17		A
Repetitive Avalanche Energy (note1)	E_{AR}	90		mJ
Power Dissipation ($T_C = 25^\circ C$)	P_D	120	416	W
Operating Junction and Storage Temperature Range	T_J, T_{stg}	-55~+150		$^\circ C$

Thermal Resistance				
Parameter	Symbol	Value		Unit
		220F	220	
Thermal Resistance, Junction-to-Case	R_{thJC}	1.04	0.3	$^\circ C/W$
Thermal Resistance, Junction-to-Ambient	R_{thJA}	62.5	60.0	



芯善物科技

MPVX20N65B Series Power MOSFET

Specifications $T_J = 25^\circ\text{C}$, unless otherwise noted						
Parameter	Symbol	Test Conditions	Value			Unit
			Min.	Typ.	Max.	
Static						
Drain-Source Breakdown Voltage	$V_{(BR)DSS}$	$V_{GS} = 0V, I_D = 250\mu A$	650	--	--	V
Zero Gate Voltage Drain Current	I_{DSS}	$V_{DS} = 650V, V_{GS} = 0V, T_J = 25^\circ\text{C}$	--	--	1	μA
Gate-Source Leakage	I_{GSS}	$V_{GS} = \pm 30V$	--	--	± 100	nA
Gate-Source Threshold Voltage	$V_{GS(th)}$	$V_{DS} = V_{GS}, I_D = 250\mu A$	2.0	--	4.0	V
Drain-Source On-Resistance (Note4)	$R_{DS(on)}$	$V_{GS} = 10V, I_D = 10A$	--	0.35	0.45	Ω
Dynamic						
Input Capacitance	C_{iss}	$V_{GS} = 0V,$ $V_{DS} = 25V,$ $f = 1.0\text{MHz}$	--	3000	--	pF
Output Capacitance	C_{oss}		--	250	--	
Reverse Transfer Capacitance	C_{rss}		--	20	--	
Total Gate Charge	Q_g	$V_{DD} = 520V, I_D = 20A,$ $V_{GS} = 10V$	--	60	--	nC
Gate-Source Charge	Q_{gs}		--	14	--	
Gate-Drain Charge	Q_{gd}		--	23	--	
Turn-on Delay Time	$t_{d(on)}$	$V_{DD} = 325V, I_D = 20A,$ $R_G = 25\Omega$	--	37	--	ns
Turn-on Rise Time	t_r		--	66	--	
Turn-off Delay Time	$t_{d(off)}$		--	175	--	
Turn-off Fall Time	t_f		--	84	--	
Drain-Source Body Diode Characteristics						
Continuous Body Diode Current	I_S	$T_C = 25^\circ\text{C}$	--	--	20	A
Pulsed Diode Forward Current	I_{SM}		--	--	80	
Body Diode Voltage	V_{SD}	$T_J = 25^\circ\text{C}, I_{SD} = 10.0A, V_{GS} = 0V$	--	--	1.4	V
Reverse Recovery Time	t_{rr}	$V_R = 400V, I_F = 20.0A,$ $di_F/dt = 100A/\mu s$	--	450	--	ns
Reverse Recovery Charge	Q_{rr}		--	7.1	--	μC

Notes

1. Repetitive Rating: Pulse width limited by maximum junction temperature
2. $I_{AS} = 17A, V_{DD} = 50V, R_G = 25\Omega, \text{Starting } T_J = 25^\circ\text{C}$
3. Pulse Test: Pulse width $\leq 300\mu s, \text{Duty Cycle } \leq 1\%$
4. Essentially independent of operating temperature

Typical Characteristics $T_J = 25^\circ\text{C}$, unless otherwise noted

Figure 1. Output Characteristics

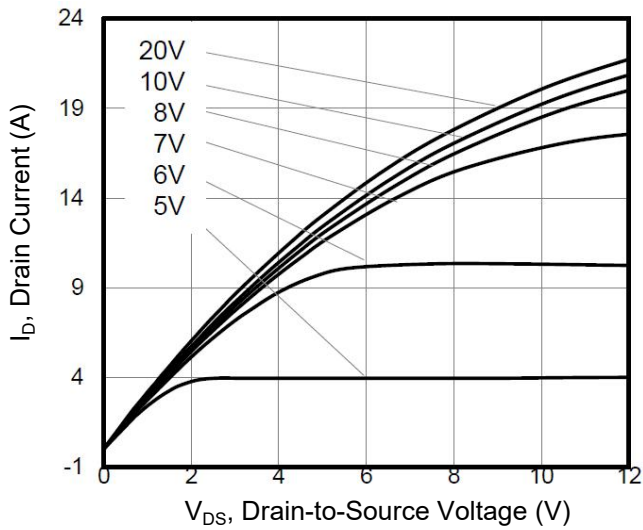

Figure 2. Transfer Characteristics

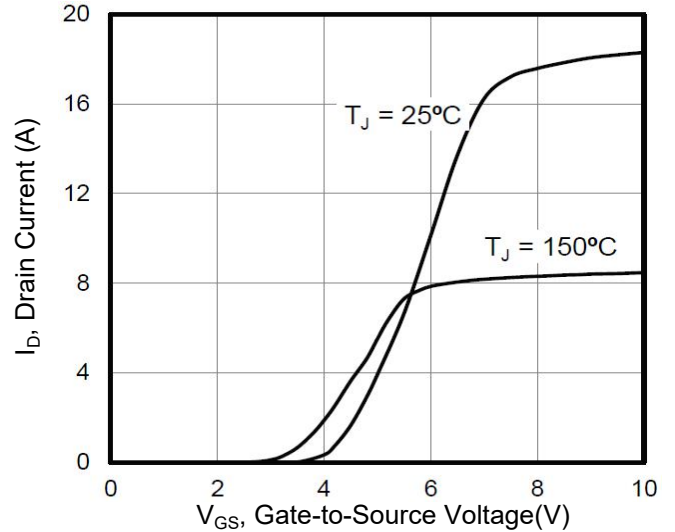

Figure 3. BV_{DSS} vs. Temperature

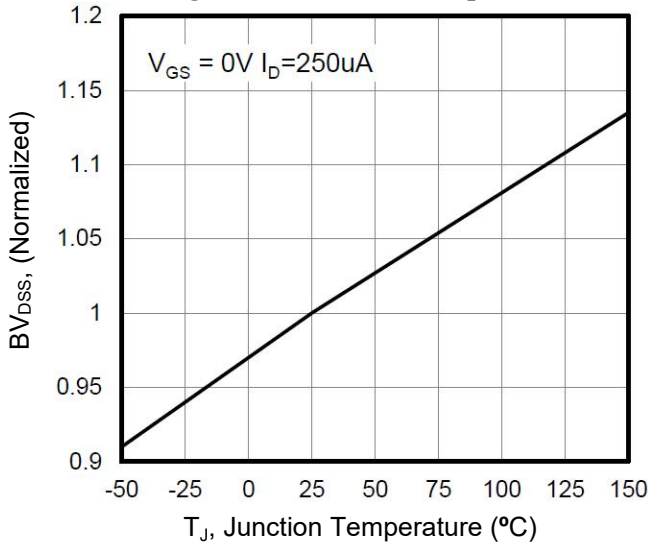

Figure 4. On-Resistance vs. Temperature

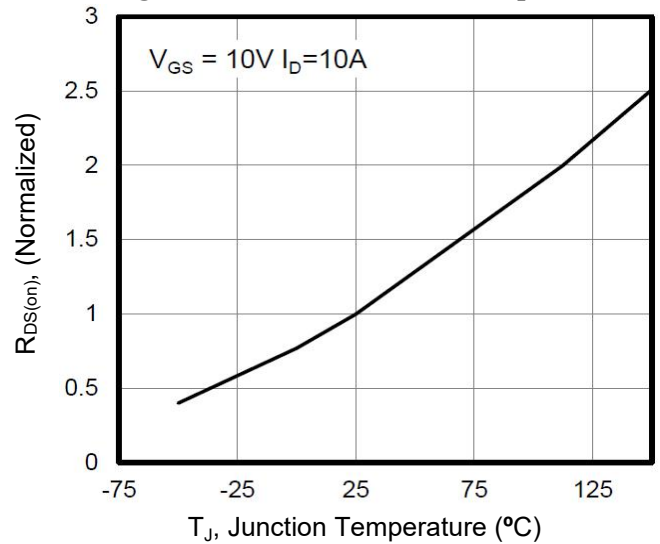

Figure 5. Gate Charge

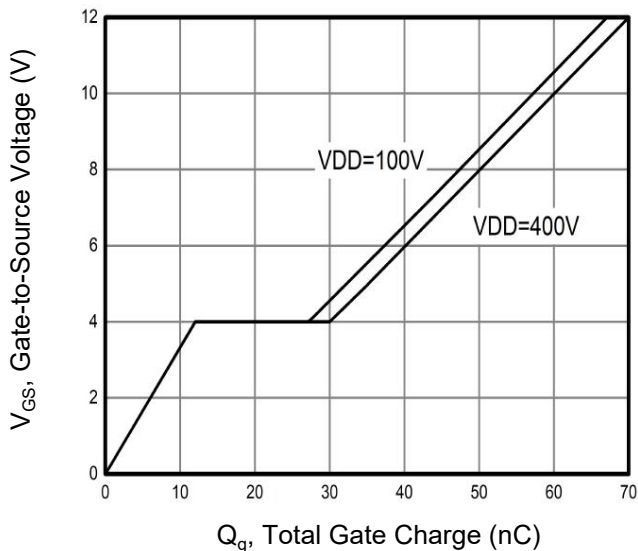
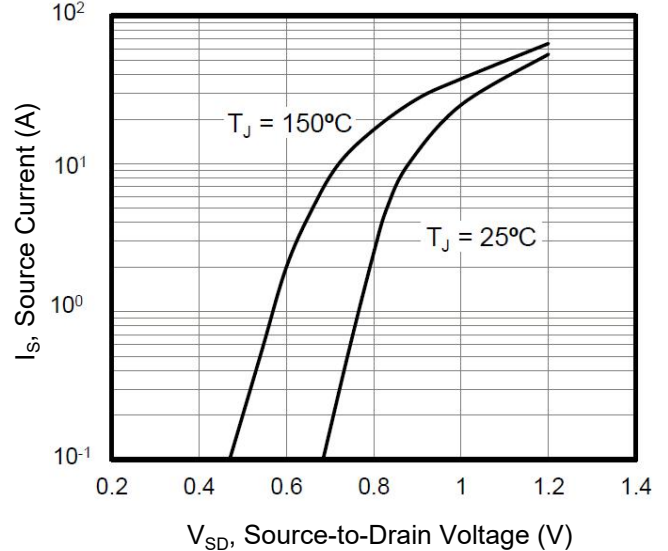

Figure 6. Body Diode Forward Voltage



Typical Characteristics $T_J = 25^\circ\text{C}$, unless otherwise noted

Figure 7. Transient Thermal Impedance
(TO-220F)

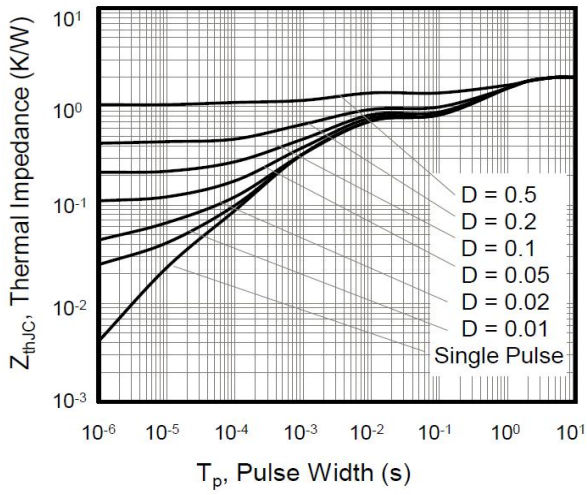

Figure 8. Transient Thermal Impedance
(TO-220)

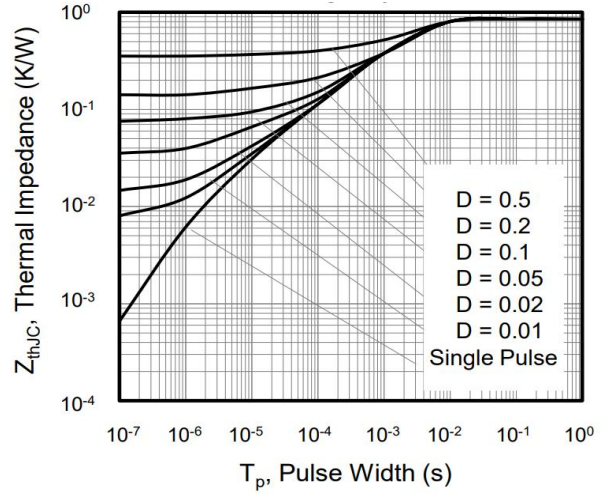

Figure A: Gate Charge Test Circuit and Waveform

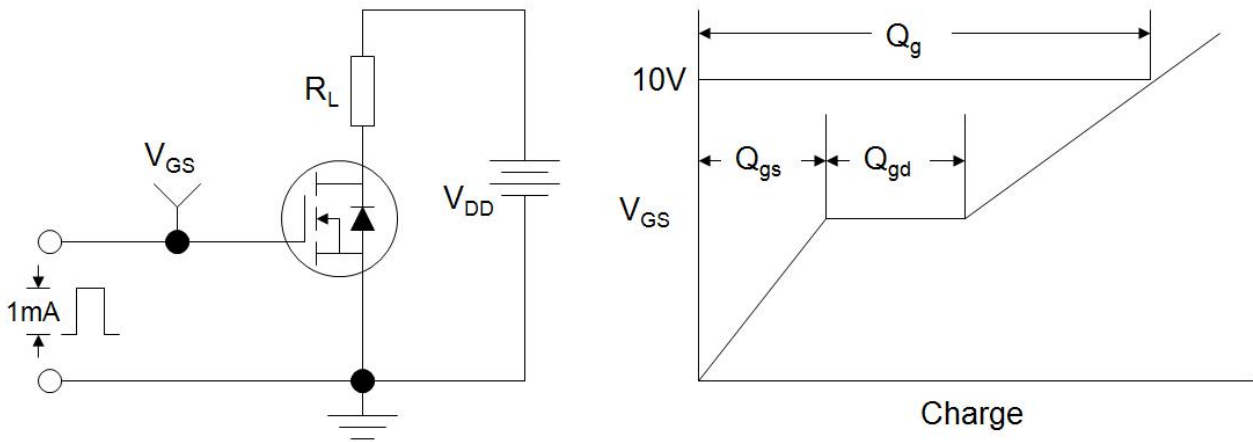

Figure B: Resistive Switching Test Circuit and Waveform

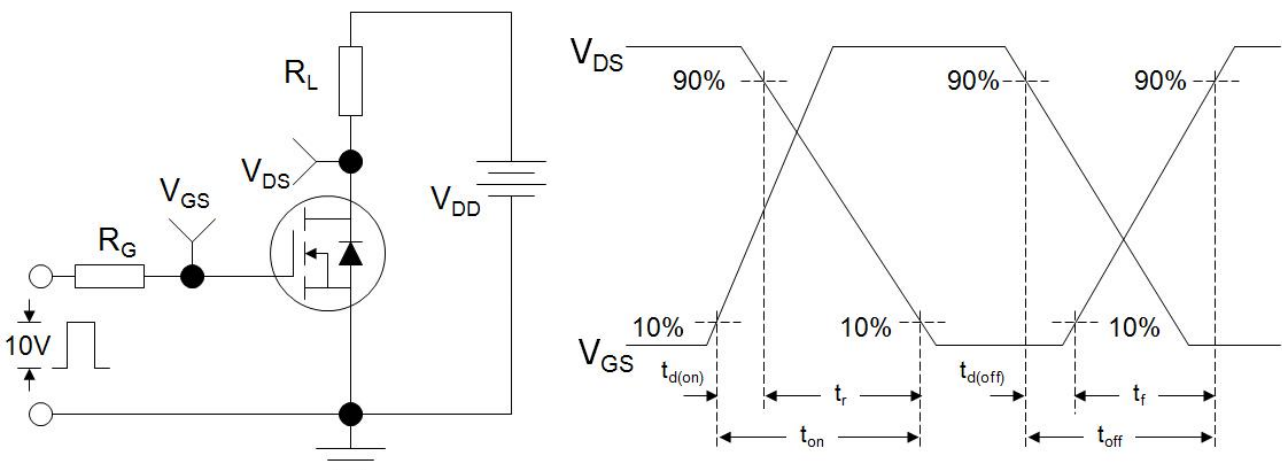
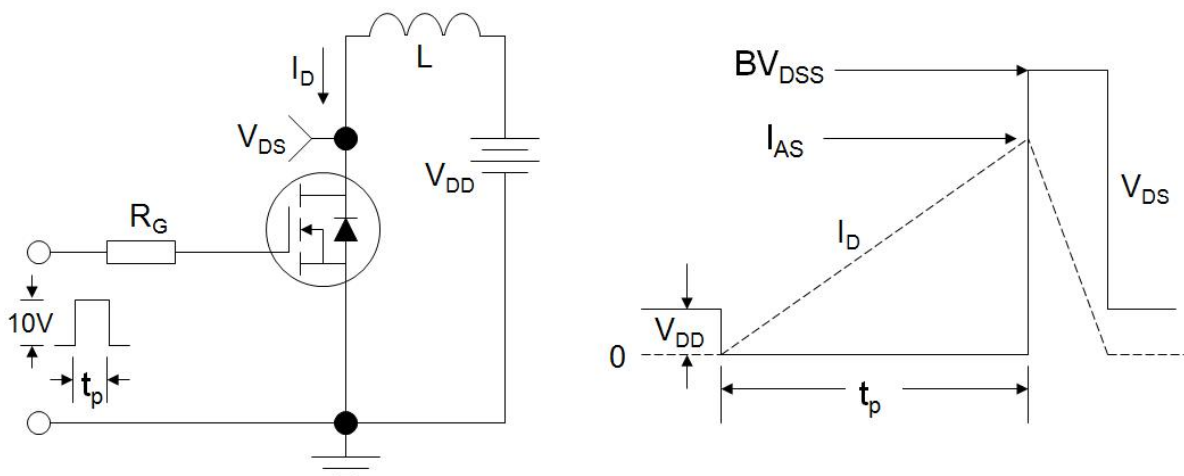

Figure C: Unclamped Inductive Switching Test Circuit and Waveform



Outline Dimension

Unit: mm

TO-220F

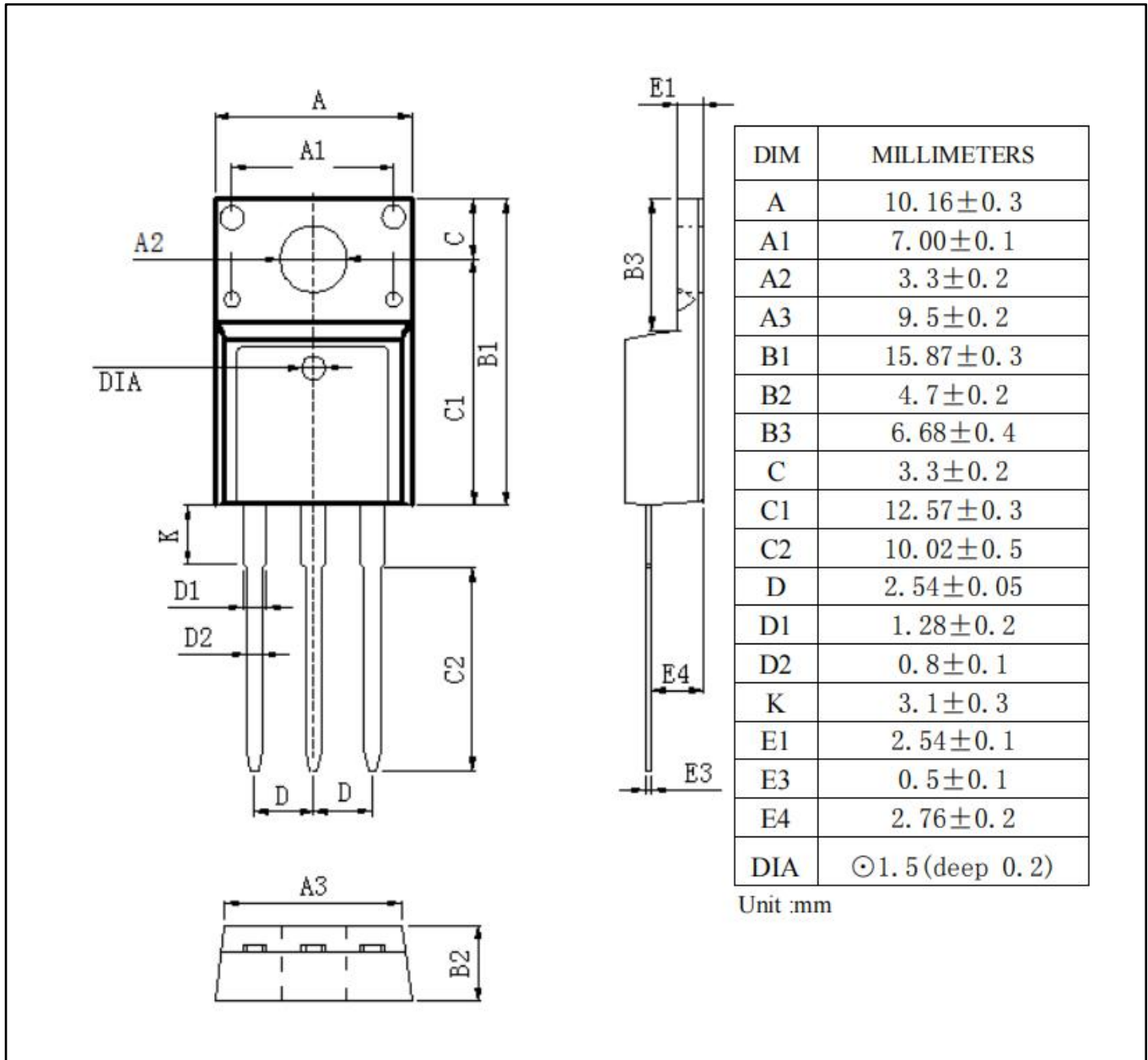

Outline Dimension

Unit: mm

TO-220

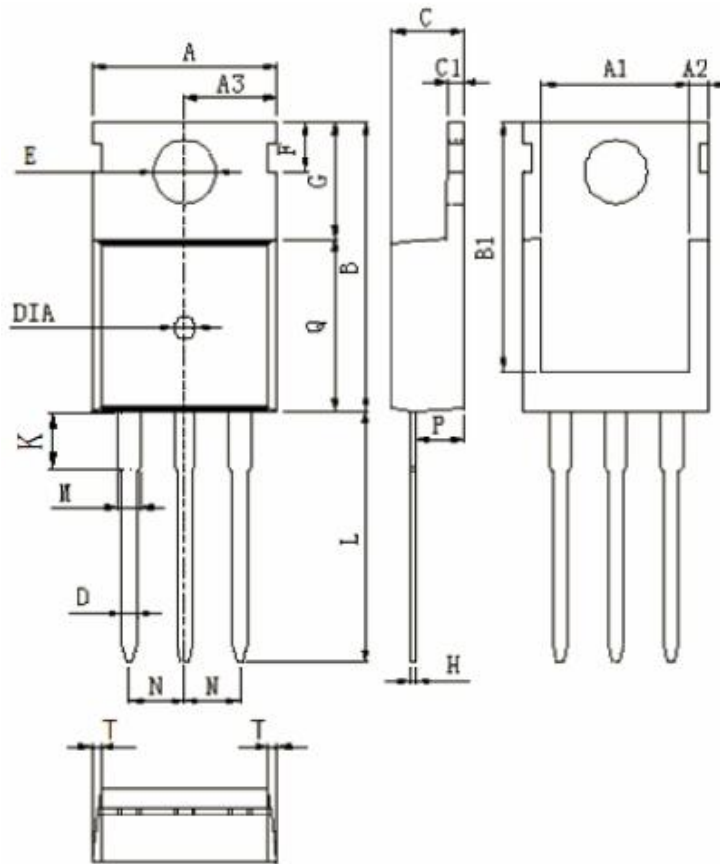

DIM	MILLIMETERS
A	10.0±0.3
A1	8.64±0.2
A2	1.15±0.1
A3	5.0±0.2
B	15.8±0.4
B1	13.2±0.3
C	4.56±0.1
C1	1.3±0.2
D	0.8±0.2
E	3.6±0.2
F	2.95±0.3
G	6.5±0.3
H	0.5±0.1
K	3.1±0.2
L	13.2±0.4
M	1.25±0.1
N	2.54±0.1
P	2.4±0.3
Q	9.0±0.3
T	W:0.35
DIA	⊙1.5(deep 0.2)

Unit :mm